

REFRIGERATORS AND FREEZERS

OPERATION, MAINTENANCE AND INSTALLATION GUIDE



GENERAL ADVICE, ACCEPTANCE OF PRODUCT, CLIMATE CLASS AND DISPOSAL OF THE DEVICE AT THE END OF ECONOMIC LIFE	2
FIRST OPERATION	5
CONTROL PANEL	7
CLEANING, MAINTENANCE AND TROUBLE SHOOTING	10
SIZE OF THE DEVICE	13
COOLING CIRCUIT DIAGRAM	16
ELECTRICAL WIRING DIAGRAM	17

PRODUCT DESCRIPTION LABEL

1-Product Code
2-Product Name
3-Model
4-Refrigerant
5-IP Protection
6-Climate Rate
7-Capacity
8-Production Date
9-Power-Current
10-Voltage-Frequency
11-Heating Element
12-System Frequency
13-Poly Gas Type
14- Serial No

ÜRÜN KODU/ PRODUCT NUMBER	1
V13.06	
14 (SERİ NO / SERIAL NUMBER)	
ÜRÜN ADI / PRODUCT DESCRIPTION	2
MODEL / MODEL	3
SOĞUTUCU AKIŞKAN / REFRIGERANT	4
KORUMA SINIFI / IP PROTECTION	5
İKLİM SINIFI / CLIMATE RATE	6
KAPASİTE / CAPACITY	7
URETİM TARİHİ / PRODUCTION DATE	8
GÜÇ - AKIM / POWER-CURRENT	9
VOLTAJ - FREKANS / VOLTAGE - FREQUENCY	10
REZİSTANS / HEATING ELEMENT	11
SİSTEM BASINCI / SYSTEM PRESSURE	12
POLIURETAN GAZ ÇİNSİ / POLY GAS TYPE	13

ÖZTIRYAKILER MADENİ EŞYA SAN. VE TİC. A.Ş. Cumhuriyet Mah. HadimköyYolu
Caddesi No:8 1Nolu Bağımsız Bölüm Büyükçekmece / İstanbul VD: BüyükMükellefler VKN:
7080013433



GENERAL ADVICE, ACCEPTANCE OF PRODUCT, CLIMATE CLASS AND DISPOSAL OF THE DEVICE AT THE END OF ECONOMIC LIFE

➤ **THE PURPOSE OF USAGE**

- The product is suitable for use in indoor areas and it is only used for the purpose of storing food and drinks. The manufacturer is not responsible for the negative outcomes that might occur during use except the purpose.
- During storage foods, it should be prevented from direct contact of foods with body of the device.
- Features of the device and condenser capacity are suitable for storing food that has been pre-cooling.
- Definitely do not put beverages housed in the box and the glass into the parts with low temperature (below freezing); cans and glass containers may explode due to expansion. Do not put hot foods or liquids into the device. The containers having a lid should not be completely filled, some room should be left.
- There are some parts keeping ice in all products. According to its model, ice is melted with automatic defrost or manual defrost. Definitely do not try to clear the ice with a hand tool or any force since it may cause damages to the device which is difficult to fix.
- To speed the defrost up, any mechanical device or different ways should not be used.
- Any changes made to the device electrically or mechanically get your device out of warranty.
- Changes made by anyone other than authorized Service Personnel and changes except the instructions given in the manual remove your device out of warranty and the manufacturer will not accept responsibility for problems that may arise.

➤ **CLIMATE CLASS**

- The device is set to run at a specific temperature, these limits are classified as follows with climate class system. Definitely do not exceed given operating temperature limits related to the devices. Climate class which the device belongs is located on product identification label.

Climate Rating	Ambient Temperatures
SN (4)	From +10 °C to +32 °C
N (4)	From +16 °C to +32 °C
ST (5)	From +16 °C to +38 °C
T (5)	From +16 °C to +43 °C

➤ **FIRST ACCEPTANCE AND CONTROLS**

Refrigerators are packed with protective material for shipment. When the device arrive you, check whether there is any damage has suffered during transport and it is suitable with your order.

When you see a defect, write the following sentences on the space related to the product into the to shipping and delivery documents.

"I have received the package explicitly damaged."

In the factory delivery way, for damages reimbursement items can be taken from insurance companies.

IMPORTANT

ALL OPERATIONS DESCRIBED BELOW SHOULD BE MADE BY CURRENT SAFETY RULES. FOR OPERATION AND USAGE OF THE DEVICE, CURRENT SAFETY RULES ALSO SHOULD BE APPLIED.



ATTENTION

BEFORE CARRYING THE DEVICE, MAKE SURE FORKLIFT OR SIMILAR DEVICE HAS ENOUGH CAPACITY TO CARRY IT.

CARRYING

Carrying with a forklift or similar device,

Insert the feet of forklift into the appropriate base portions of the pallet. Start lifting, in the meantime, is sure to check the stability of the device.



ATTENTION

DURING CARRYING, DO NOT DOWN THE DEVICE AND OVERTHROW IT.

IF YOU CARRY DEVICE HORIZONTALLY, WAIT AT LEAST TWO HOURS BEFORE OPERATE THE DEVICE. (IT ISN'T RECOMMENDED TO CARRY THE DEVICE HORIZONTALLY. THE WARRANTY DOES NOT COVER THE DAMAGES THAT CAN OCCUR AT HORIZONTAL TRANSPORT.)



ATTENTION

RECOMMENDATIONS WRITTEN OUTSIDE THE DEVICE AND PACKAGE, SUITABILITY OF THE DEVICES FOR THE PHYSICAL AND WORKING CONDITIONS PROVIDE USERS BENEFITS. THEREFORE, THE FOLLOWING RECOMMENDATIONS SHOULD BE OBSERVED.

- CARRY IT CAREFULLY.
- IT SHOULD BE KEPT DRY.
- STACKING DIFFERENT ITEMS ON DEVICE SHOULD BE AVOIDED.

➤ OPENING THE PACKAGE

Cut plastic strips with scissors.

Carton and other packaging must be removed.

Wood Packaging

Starting from the top and the front, the nails are removed.

Remove the plastic packaging.

Plastic Packaging

Glued strips of nylon are dismantled and removed.

Lift the device to disconnect it from pallets.

Place the device to the desired location on the base surface

Check the damage seen.

Since packaging materials can harm children, they must be removed in a way that children cannot reach.

Packaging materials must be left to special recycling points. (Existing rules and laws are applied.)

Check the product code and (If there is) serial number on the shipping documents.

➤ DISPOSAL OF THE DEVICE AT THE END OF ECONOMIC LIFE

The device has a cooling gas located on the product identification label. European Union Regulations (EC) No. 2037/2000 of 29 June 2000; the device is made from recyclable materials. Therefore, at the end of the economic life of the device, it must be given to special recycling centers. To make sure that there's anything in the device; control it by opening the door.

Devices must not be recycled with metallic materials and household waste.

Deformation of the cooling plant should definitely be avoided. Especially, attention should be paid to the parts of heat transfer.

**IMPORTANT**

DURING DISPOSAL OF THIS TYPE OF DEVICE, LOCAL RULES AND LAWS ARE VALID.

**IMPORTANT****Important warnings for refrigerators using HC (R 600a/r290) gas;**

Refrigerators operated with HC gas must not be placed in a smaller place than 10 m³ volume. Of the cases required, air flow with 14 cm. vent to a large volume room or outdoor environment must be provided.

Do not intervene except for authorized service.

Parts need to be changed for repair (Compressor, condenser, dryer, evaporator, solenoid valves, and capillary tubes) must be replaced with welding displaced after emptying gas with vacuum process.

To interfere with flame to a pressurized system before HCl gas is discharged may create explosive effect and cause serious injury. These gases are flammable. Therefore after handling and transport, be careful not to damage the pipes and the cooling system. If damage occurs, keep the device out of potential sources that may lead to ignition and immediately ventilate the room in which there is the product.

You can learn the information of the product is produced with which gases, looking at the upper-left label located on the inside of the product. Do not take into account these warnings with systems containing R134a and R404a.

FIRST OPERATION**IMPORTANT**

BEFORE ELECTRICAL CONNECTION OF THE DEVICE, CHECK WHETHER LABEL PRODUCT IDENTIFICATION OF INFORMATION IS SAME WITH YOUR LOCAL NETWORK POWER SUPPLY.

LABEL PRODUCT IDENTIFICATION INCLUDES ELECTRICAL INFORMATION REQUIRED FOR INSTALLATION. THIS LABEL TAKES PLACE IN INTERIOR AND UPPER LEFT SIDE OF THE DOOR OF THE DEVICE.

INSTALLATION OF THE DEVICE MUST BE DONE BY A QUALIFIED AND TRAINED SERVICE PERSON ACCORDING TO THE INFORMATION CONTAINED IN THIS SECTION.

ELECTRICAL SAFETY OF THIS DEVICE IS ONLY VALID THE GROUNDING IN ACCORDANCE WITH THE LOCAL LAWS AND SAFETY DEFINED IN THE LAWS.

THE MANUFACTURER DOES NOT TAKE RESPONSIBILITY FOR ANY DAMAGES ARISING FROM IMPROPER GROUNDING.

THE DEVICE MUST BE CONNECTED FROM EQUIPOTENTIALS POINT SYSTEM TO THE EQUIPOTENTIAL GROUNDING. SUITABILITY OF THIS EQUIPOTENTIALS GROUNDING SYSTEM MUST BE APPROVED WITH LOCAL LAW AND DEFINED THE LAW.

VARIOUS ADAPTER, MULTI PLUG AND / OR USE AN EXTENSION CORD ARE STRICTLY PROHIBITED.

➤ **GENERAL PRELIMINARY CHECKS**

Make sure the base of the device will remove the weight and it is horizontal.

Make sure the device in a horizontal level and it is balanced. If necessary, adjustable feet level of the device can be adjusted. If necessary, level meter can be used for the control. Maximum allowable slope of horizontal is + / - 0.5 degrees. All the feet should press the base. This provides proper operation of the door.

Ensure proper air flow and to avoid damage to the cooling circuit, the spacing at least 50 mm in vertical refrigerators from sides and top and 15 mm from rear in the horizontal refrigerators are sufficient.

Do not place the device near heat generating sources; for example, oven, radiators, etc. Do not expose to direct sunlight. Heat may come from the walls and floors must be insulated with appropriate insulating material.

If location of the device is changed, it must be waited for a while before starting up again. If the device isn't transported vertically, waiting time must be at least 2 hours. Property damage that may occur due to horizontal transport is out of the covered by the warranty.

Plastic protection or tapes should be removed from the outer surface.

Internal parts should be washed with warm and slightly soapy water. Damage caused by cleaners containing chemicals that can react with stainless steel is not covered by the warranty.

The device should be placed in possible farthest point from the heat source.

Outside air flow to the engine must not be blocked.

If possible, lock the keys to keep away from children.

➤ **PRELIMINARY ELECTRIC CONTROLS**

Mains voltage and frequency marked on the product identification label must conform to the values.

Connectors so as to provide security should be on the clipboard. (They may loosen during shipment or relocation.)

The device is connected to the electrical outlet with a 16 A fuse as a serial connection.

Turn off the main fuse connected to the power cable.

Check whether the plug of the device is suitable for outlet to be used. If the outlet is not suitable, the outlet is changed by the authorized person. Authorized person must also check whether the cable cross-section is suitable for the power of the device. Check whether the plug enter into the outlet.

FIRST OPERATION AND CONTROLS

After the above checks, the device can be operated.

On / off switch operate devices.

After the device is turned to the ON position, the compressor will start running. . The compressor runs until the temperature in the device set the factory temperature. Until the temperature is the adjusted degree, any materials must not be placed into it. If the material needs special storage temperature, the set value must be displayed on the screen of the digital thermostat.

To change the factory setting, it must be set from the control panel settings.



IMPORTANT

YOU MUST WAIT FOR THE SET TEMPERATURE BEFORE MATERIALS PLACING INTO THE DEVICE.

THE SIGN SHOWING MAXIMUM LOAD LEVEL IN THE DEVICE MUST NOT DEFINITELY BE PASSED.

GENERAL INFORMATION ABOUT AMOUNT OF SPACE INTO THE SIDE AND TOP IS AVAILABLE IN PRELIMINARY CONTROLS SECTION.

➤ OPERATION

To increase safety and hygiene in food stuffs, suitable storage conditions are very important. Proper storage conditions improve quality of service; there is also a positive contribution to energy consumption. If those described below are done, the best performance is obtained from the device. Materials should be kept on the shelves at all times. Do not definitely put material to the bottom of your device.



IMPORTANT

MATERIALS MUST BE PLACED IN THE DEVICE SO AS TO THEY WILL NOT BLOCK THE AIR FLOW.

ALWAYS LEAVE SOME SPACE BETWEEN THE MATERIALS AND AVOID CONTACT WITH WALLS OF THE DEVICE.

IF NEEDED, SHELF DISTANCE CAN BE ADJUSTED.

CONTROL PANEL

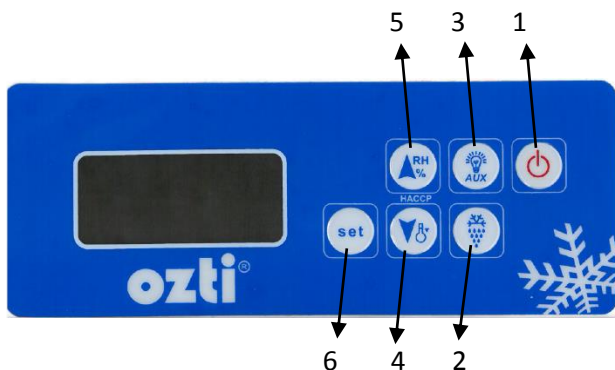

➤ **FRONT PANEL FUNCTIONS**

To lock the front panel keys, hold AUX (3) and hold On / Stand By (1) for 2 seconds: "Loc" text will be on the screen when keys are locked, if it isn't locked, "UnL" text will be on the screen.

1) When holding ON/STAND BY for 4 seconds; the device opens or closes. (On/Off)

2) MANUAL DEFROST; if the button is pressed for 4 seconds, manual defrost starts. If excessive cooling is active and evaporator temperature is not suitable, manual defrost will not start.

3) It is used to only for models with glass doors to open or close the cabin interior lighting (On / Off) or if there is, the auxiliary output turns on and off the ignition (On / Off).

4) DOWN key: Scroll down the menu or reduce the value; if held down for 4 seconds super cooling becomes active. When excessive cooling function is active, the set temperature can be reduced; the time and temperature are determined with the help of the parameters. When excessive cooling function is activated, the device never does defrost.

5) UP Key: Scroll up the menu or increase the value; if held down for 4 seconds, percentage of low and high relative humidity function is engaged. (For some models) "rhL" is written on the screen (A low percentage of relative humidity function is operating.) or "rhH" is written on the screen (A high percentage of relative humidity function is operating.) These functions appear on the screen for 10 seconds. If humidity control is not available, "----" appears on the screen for 1 second.

6) SET key: input and change key for adjustable values.

➤ **OPERATING**

Operation cases are available below:

"On" status: (The device is energized and the device operates.)

"Stand-By" status: (The device is switched off, but the device is still powered.)

"Of" status: To turn the device off, remove plug from the socket or by turning main fuse off, the device is turned off.



IMPORTANT

DO NOT REPAIR OR ANY MAINTENANCE WHILE DEVICE IS "ON" or "STAND-BY". AFTER POWER SUPPLY IS CUT COMPLETELY FROM THE DEVICE, MAINTENANCE AND REPAIR CAN BE DONE.

If the front panel is in the open position, it shows the cabin temperature during normal operation. If there are evaporator and condenser probe, it can also show the temperature wherein.

If Down (4) button is held down for 2 seconds, "Pb2", "Pb3" are seen on the screen.

After waiting for a short time or pressing the SET button for short period of time, displaying the cabinet temperature returns.

➤ **CLOSE THE BUZZER (IF APPLICABLE)**

It is closed by pressing any key for a short time.

➤ **ENTERING THE VALUE TO BE SET**

SET (6) key is pressed and released: Compressor LED begins to blink.

UP (5) key is pressed and released or DOWN (4) key is held down for 15 seconds.

SET (6) key is pressed and released or wait 15 seconds without doing anything; compressor LED will turn off, then the device will finish the process.

➤ **MAIN HACCP FUNCTIONS**

The device memory can save three HACCP alarm. The device provides the following information;

Critical values

Alarm times (From 1 minute to 99 hours 59 minutes, the alarm is silenced while working.)

CODE	ALARM TYPE	CRITICAL VALUES
AL	Minimum temperature alarm	minimum cabin temperature during this alarm
AH	Maximum temperature alarm	maximum cabin temperature during this alarm
Id	Open door alarm	maximum cabin temperature during this alarm

If a new alarm worse than registered one, the device shows it or it says that the same information is available.

If the device turns off, any alarm recording cannot be done.

When the alerting reasons disappear, the display will continue to standard work.

HACCP LEDs provide information about the status of the HACCP alarm memory;

➤ **RECEIVED INFORMATION ABOUT HACCP ALARMS ON THE SCREEN**

Press DOWN (4) key for 2 seconds: first label appears on the screen.

Press and release UP (5) key or select "LS" pressing DOWN (4) key.

Press and release SET (6) key: one of the codes above appears on the screen.

To select an alarm:

Press and release UP (5) key or press UP (4) ("AH" selection will be shown.)

To show information about the alarm:

Press and release SET (6) key: flashing HACCP LED light is off and the screen gives the following information (example):

SCREEN	MEAN
8,0	critical values 8,0 °C/°F
Dur	The display shows the alarm time
h01	1 hour alarm (cont.)
n15	1 hour and 15-minute alarm
AH	Selected Alarm

To exit from the Information repeatedly:

Press and release ON/STAND-BY (1) key: selected alarm will be displayed on the screen. (e.g."AH3").

To exit process:

Exit from Information repeatedly.

Press and release UP (5) key or press DOWN (4) key until the display shows the interior temperature or wait for 60 seconds without any operation.

Alternative methods for exiting information

Press and release ON/STAND-BY (1) key:

If there aren't any alarm recordings, "LS" label will not appear.

CLEANING, MAINTENANCE AND TROUBLE SHOOTING

This section is a special section to the end user and gives very important information for the correct use and the longevity of the device.

If a few simple steps is made consciously during periods of adjustments, maintenance fee, will be carried out by authorized service, can be avoided. This care does not require special technical knowledge.



IMPORTANT

BEFORE YOU BEGIN CLEANING AND MAINTENANCE ON THE DEVICE, SEPARATE ELECTRICAL CONNECTION OF THE DEVICE FROM THE POWER SUPPLY.

ATTENTION

DO NOT WASH THE DEVICE DIRECTLY WITH HIGH PRESSURE WATER. AVOID GET ON OR SPRAYING THE WATER TO THE ELECTRICITY SUPPLIES.

➤ CLEANING

How often the device has to be cleaned depends on how frequently the device is used.

You can program lifetime and cleaning will be done after analyzing it.

To clean the interior and exterior of the device, detergents containing neutral or slightly alkaline may be used.

It is recommended that sometimes cleaning with a disinfecting material for the inside of the device. Dirt can be cleaned with a damp cloth. To remove the shelves makes the cleaning easy for the device.

Never use metal material during the cleaning.

While cleaning the inside of the cabin, clean carefully the sections of the shelves.

IMPORTANT

DEVICE IS MADE OF AISI 304 STAINLESS STEEL. WHEN USED IN NORMAL CONDITIONS, STAINLESS STEEL PREVENTS CORROSION. DO NOT USE HAZARDOUS DETERGENTS OR CLEANING MATERIAL WHICH CAN HARM THE DEVICE.

➤ **ROUTINE MAINTENANCE**

CONDENSER

It is very important that the condenser does maximum heat transfer. Therefore the surface of the condenser needs to be always clean. Maybe with the effect of the fan, dust may have accumulated in the intermediate section of the condenser. Using a device that intake and soft brush, all pollution in the intermediate compartment and above the condenser (paper, dust, etc.) can be cleaned.

Not to damage the condenser, be very careful while cleaning the grill and the fan with a brush.

If there is filter, remove the filter and clean it. Then, replace it. If it is damaged or too dirty, obtain new filter for change and replace it.

DOOR / DRAWER GASKETS

A gasket in good condition provides well to close undamaged door or drawer.

SUPPLY CABLE (POWER CABLE)

The supply cable connecting the device to the mains must not be broken or cut. Broken and cuts power supply wire damage the insulation and they are dangerous. In such cases, contact your authorized service.

➤ **IN CASE OF A LONG TIME STAY CLOSED OF PRODUCTS**

The following procedures must be performed in not long-functioning devices:

Set the main fuse OFF.

The plug of the device is removed from the wall socket.

Empty the device, clean it as described in cleaning section.

To get rid of the smell inside the device, leave the door open.

Clean contamination occurs at the compressor.

➤ **CHANGE THE ILLUMINATION LAMP (IT IS NOT VALID FOR THE DEVICE WITH GLASS DOORS)**

To change the illumination lamp, follow the steps below:

Turn off the device, (Off position) and remove the plug from the outlet.

Open the door; by removing the canopy screw, lift it up.

Unscrew the illumination lamp and replace it with a new one. The new lamp must have the same properties with the old lamp. (The lamp voltage is written on the lamp.)

➤ **FAILURES**

Solutions to the problems that may occur with the device are given in the table below. The information provided here does not include all of the problems that may occur.

If the safety device is activated, it means that there is a malfunction with the device; before reset, abolish the reasons found before. You can find potential problems and their causes in the list below.

After you make the following checks if you still have error or malfunction, please contact an authorized service.

The characteristic of the failure must be determined; product code and serial number are available from product identification labels.

PROBLEM	
	Possible cause of malfunction
	What can be done?
1. THE DEVICE IS NOT WORKING	
1.1	The device is not connected to the electricity network.
	Check the plug of the device properly passed or failed into an outlet.
2. THE COMPRESSOR RARELY STOPS	
2.1	Ambient temperature is too high
	The suitability of the environment ventilation is controlled.
2.2	The condenser unit is dirty.
	Pollution must be checked regularly and properly cleaned.
2.3	Low refrigerant charge
	Authorized service is called; leakage detection and repair of leaks are done.
2.4	Door gaskets do not provide sealing properly.
	Authorized service is called and gaskets are replaced.
2.5	Evaporator icebound
	Do not put hot food stuff and food containing water densely in it to into the device. If necessary, make the device manual defrost.
2.6	Evaporator fan or fans are faulty.
	Authorized service is called to change the fan.
3. OVERFLOW WATER FROM CONDENSER CONTAINER	
3.1	Frequently putting hot food stuff and food containing water densely into the device.
	Frequently not putting hot food stuff and food containing water densely into the device.
3.2	Frequently opening doors and / or drawers
	Form and conditions of use of the device must be considered.
4. CABIN TEMPERATURE IS HIGH	
4.1	Condenser is very dirty.
	Contamination must be checked regularly and it must be properly cleaned.
4.2	In the section of the cooling group is weak or improper ventilation
	Things which prevent proper air flow are removed.
4.3	Hot air is coming into the cabin.
	Check that the door is closed properly and check that gasket is proper. If there is no work properly, please call the Service Department. Authorized service makes the necessary changes and adjustments.
4.4	Evaporator icebound
	Manual defrost must be done.

DIMENSIONS:

GN 600

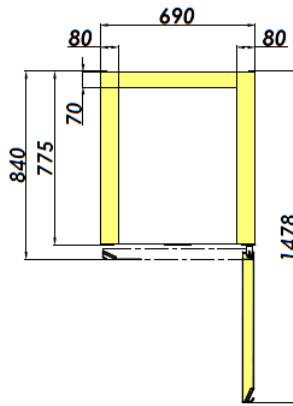

GN 1200

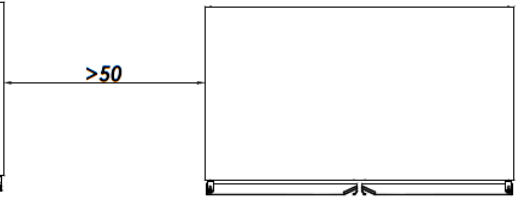
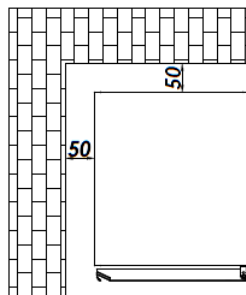
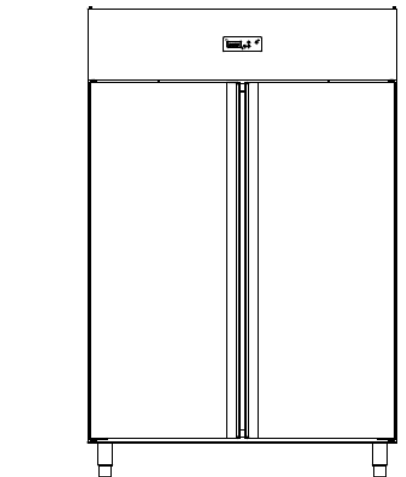
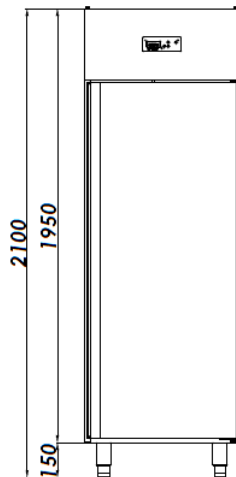
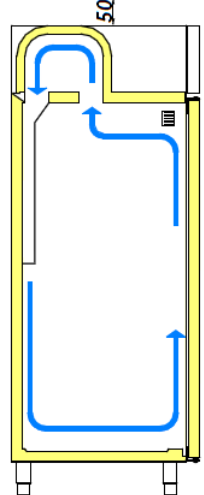
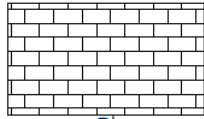
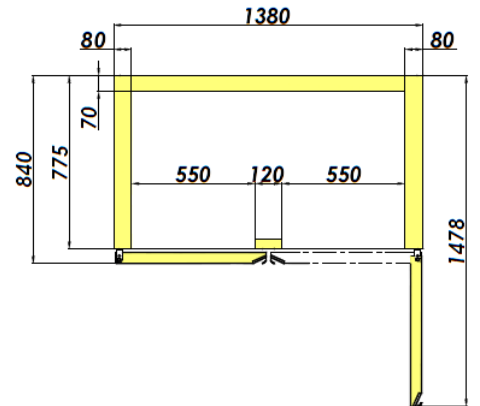

TA 260

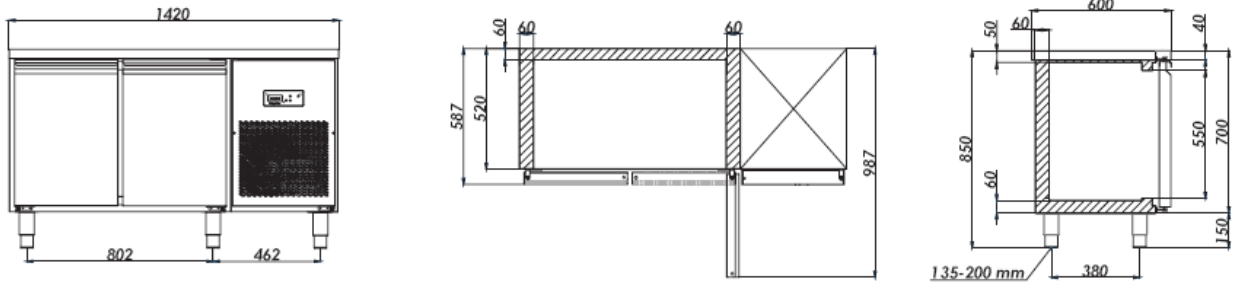

TA 360

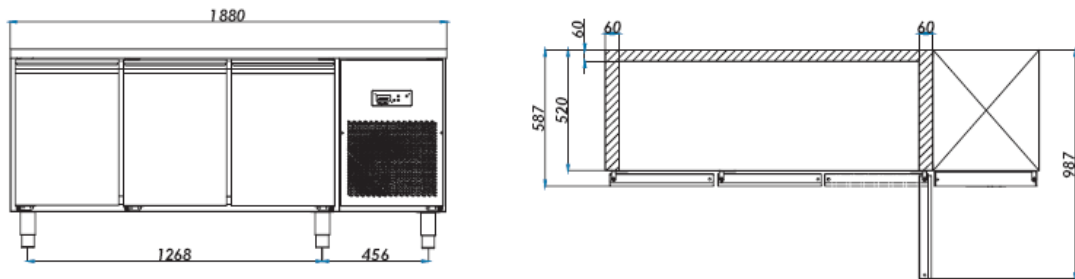

TA 460

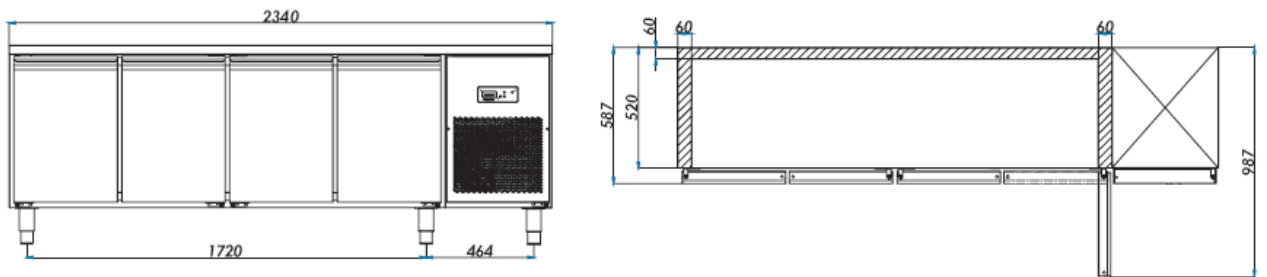

TAG 270

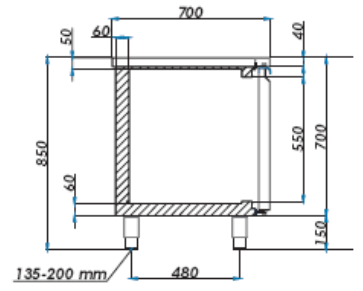
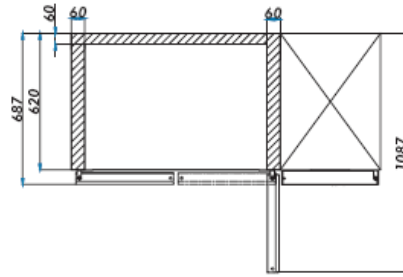
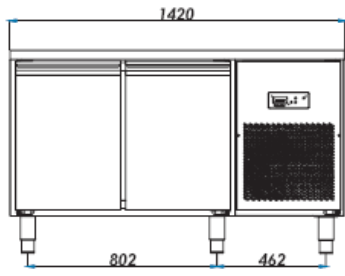

TAG 370

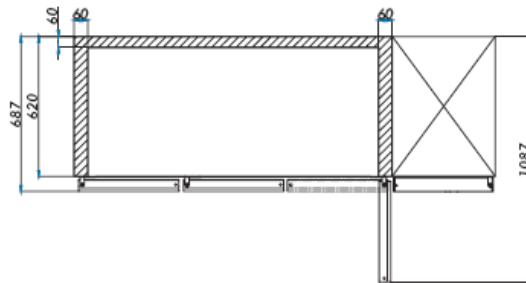
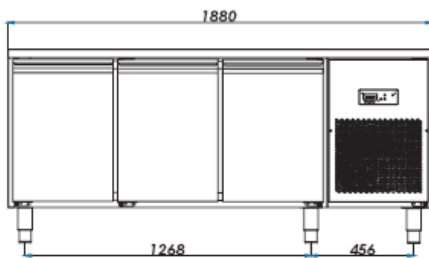

TAG 470

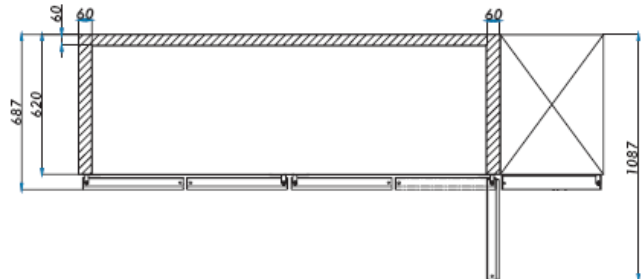
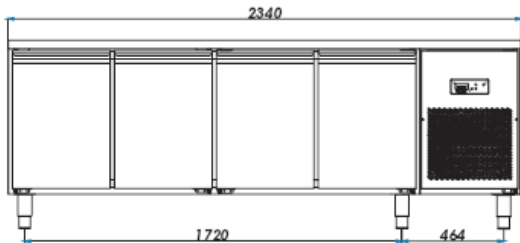

COOLING CIRCUIT DIAGRAM

Central Cooling System,

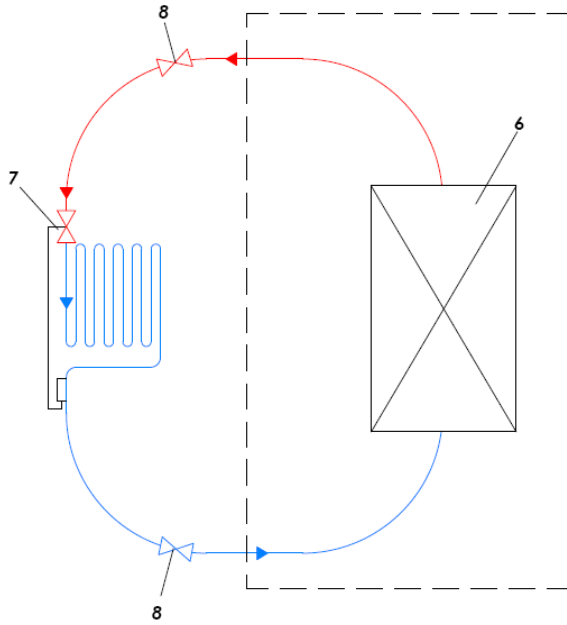

Standard Cooling System

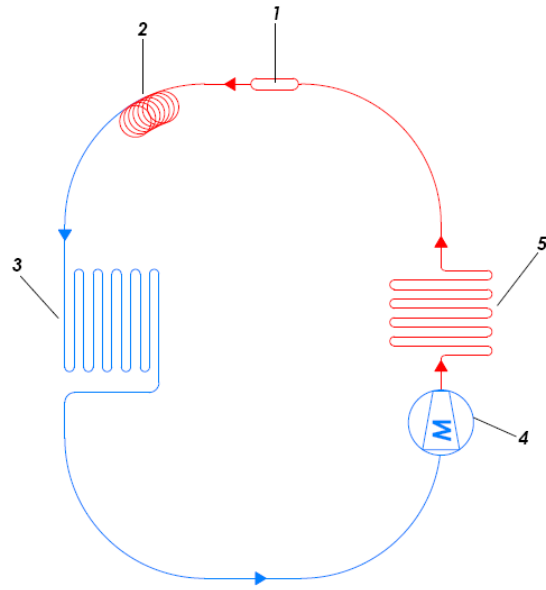

- 1- Dryer
- 2- Capillary Tube
- 3- Evaporator
- 4- Compressor
- 5- Condenser
- 6- External fed systems "remote unit" must be used.
- 7- Expansion Valve
- 8- Solenoid Valve

ELECTRICAL WIRING DIAGRAM

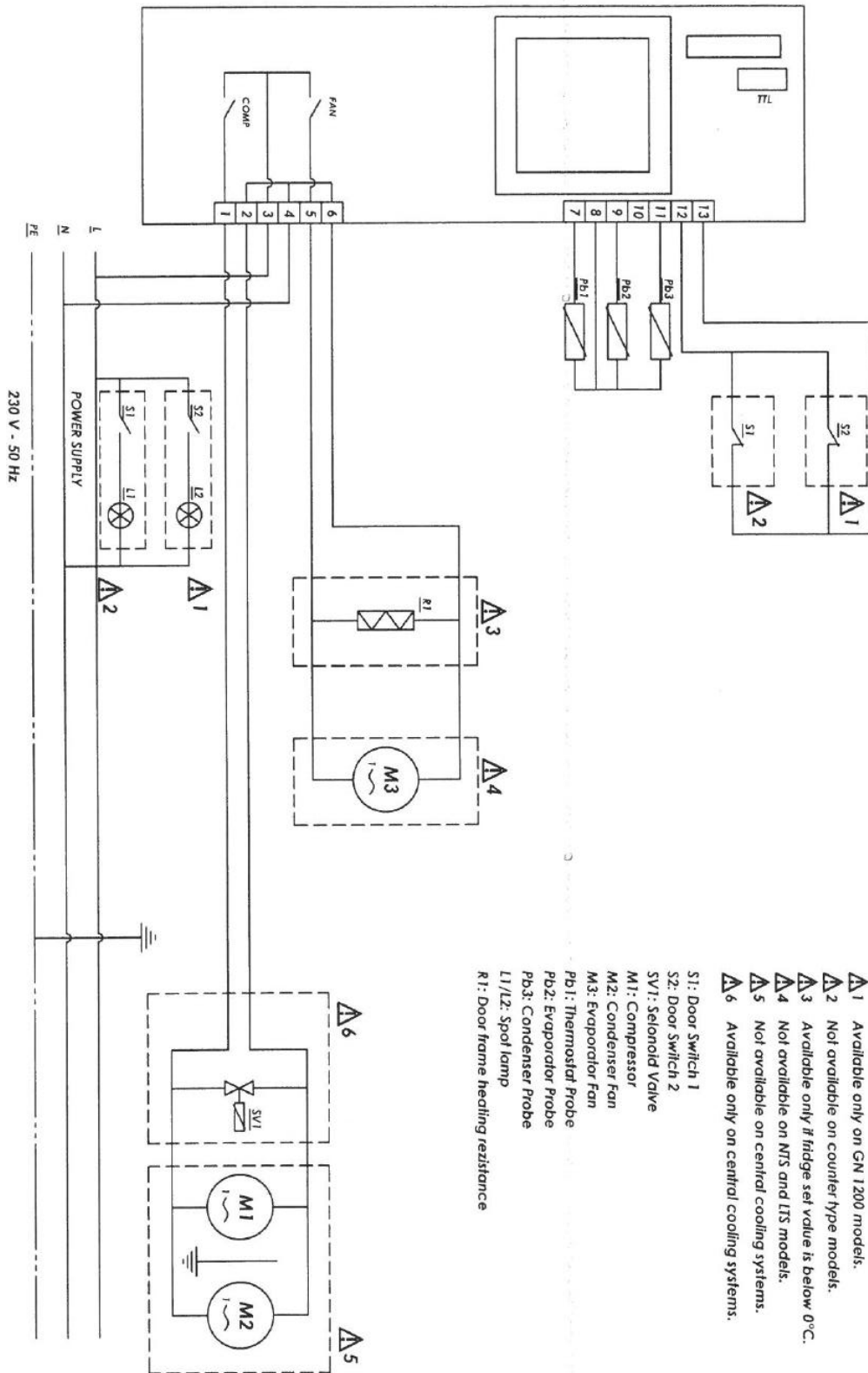

- All Rights Reserved!
- When required, Öztiryakiler reserves the right to change all the features and the information!