

# BLAST CHILLERS

E5  
E10  
E15  
T14/2  
E20  
T20  
T24  
T30  
T40  
T50  
MT

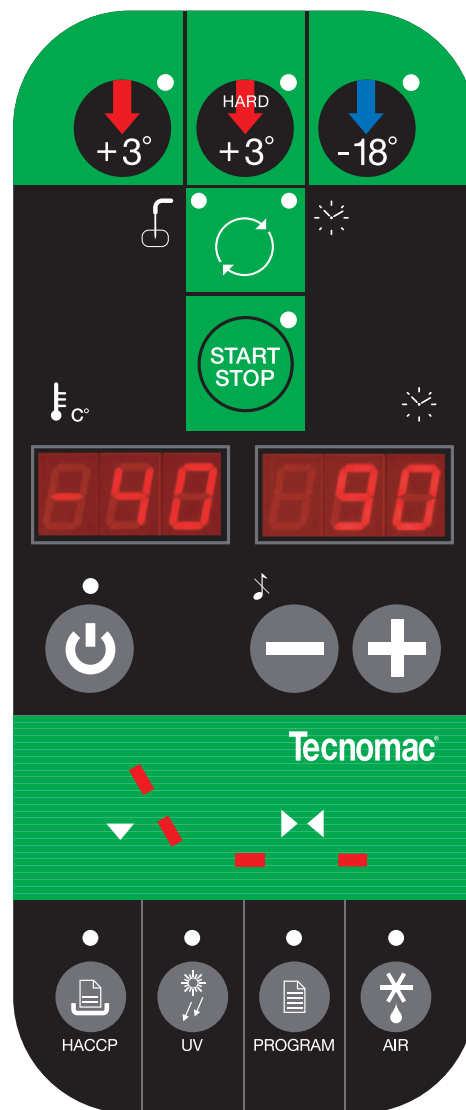

## INSTRUCTION MANUAL



# **WARNING !!!**

***THE FOLLOWING OPERATIONS AND  
THOSE HIGHLIGHTED BY THIS SYMBOL  
MUST NOT BE PERFORMED BY THE  
APPLIANCE USER***

- 1. ELECTRICAL CONNECTIONS**
- 2. WATER CONNECTIONS**
- 3. INSTALLATION**
- 4. TESTING**
- 5. REPAIRING MACHINE COMPONENTS**
- 6. DISASSEMBLY OF THE APPLIANCE AND/OR ITS COMPONENTS**
- 7. ADJUSTMENTS AND CALIBRATION**
- 8. CLEANING THE APPLIANCE AND MAINTENANCE OF:**
  - ELECTRICAL PARTS,**
  - ELECTRONIC PARTS,**
  - MECHANICAL PARTS,**
  - REFRIGERATION SYSTEM PARTS**

## CONTENTS

### 1. GENERAL DOCUMENTATION

1.1	General information	page	5
1.2	Installation	page	5
1.3	Transport and handling	page	5
1.4	Unpacking - disposal of packaging materials	page	5
1.5	General safety regulations	page	6

### 2. INSTALLATION

2.1	Data plate information	page	6
2.2	Positioning	page	6
2.3	Ambient temperature and air circulation	page	7
2.4	Electrical connections	page	7
2.5	Refrigeration component connections - remote assemblies	page	7
2.6	Condensate drainage connection	page	7
2.7	Information for the installation technician	page	7
2.8	Safety and control systems	page	8
2.9	Appliance disposal	page	8

### 3. ADVICE TO ENSURE EFFICIENT APPLIANCE OPERATION

3.1	Shut-down procedures	page	9
3.2	Operating tips	page	9
3.2.1	Precooling	page	9
3.2.2	Loading the appliance	page	9

### 4. DESCRIPTION OF THE CONTROL PANEL **page 10**

4.1	Push-buttons	page	11
-----	--------------	------	----

### 5. PROGRAMMING AND OPERATING INSTRUCTIONS

5.1	Starting up the appliance	page	12
5.2	Soft blast chilling by temperature	page	12
5.3	Soft timed blast chilling	page	14
	Hard blast chilling	page	14
5.4	Hard blast chilling by temperature	page	14
5.5	Hard timed blast chilling	page	15
5.6	Blast freezing by temperature	page	16
5.7	Timed blast freezing	page	17

**6 APPLIANCE FUNCTIONS**

6.1	Date and time settings	page	18
6.2	Ice cream surface hardening	page	18
6.3	Muting the beeper and alarm reset	page	18
6.4	Program storage	page	18
6.5	Displaying the three latest HACCP alarms	page	18
6.6	Printing out stored data	page	18
6.7	Forced ventilation function	page	19
6.8	User programming	page	19
6.9	Manual defrosting	page	19
6.10	Automatic defrost cycles	page	19

**7. ALARM MANAGEMENT**

7.1	Storage of data/errors	page	20
7.2	Alarms list	page	20

**8. MAINTENANCE AND CLEANING**

8.1	General safety regulations	page	22
8.2	Cleaning the condenser	page	22
8.3	Cleaning the cell	page	23
8.4	Defrost water drainage	page	24

# 1. GENERAL DOCUMENTATION

## 1.1. General information

- This manual is an integral part of the product, providing all the information required to ensure correct installation, operation and maintenance of the machine.
- Read the manual carefully, making reference to it for machine operation. Keep the manual in a safe place where it can be accessed by all authorised operators (installers, operators and service personnel).

The machine has been constructed in compliance with the directives 73/23/CEE (low-voltage), 89/336/CEE (electromagnetic compatibility) and 98/37/CE (machines; for certain models only).

- The machine has been designed for professional applications only and should only be operated by qualified personnel.
- The machine must only be used for the purposes for which it was designed, i.e. for chilling and freezing food products.

The machine must not be used for products requiring constant temperature control and recording, such as:

- heat-sensitive chemicals,
- medicines or
- blood products.

- The manufacturer declines all responsibility for any damage caused by incorrect or unreasonable machine use, such as:

- improper use by untrained persons;
- technical modifications or operations not suited to specific models;
- use of non-original or non-specific spare parts;
- failure to follow the instructions given in this manual.

This appliance is not intended for use by persons -including children- with reduced physical, sensory or mental capabilities, or lack of experience and knowledge, unless they have been given supervision or instruction concerning use of the appliance by a person responsible for their safety. Children should

be supervised to ensure that they do not play with appliance.

## 1.2 Installation

The machine must be installed by a specialised technician authorised by and in compliance with the instructions given in this manual.

In the event that the machine is fitted with a remote condenser unit, the installation technician is responsible for checking all connections in compliance with the instructions given by for plant and machine installation.

## 1.3 Transport and handling

- To load or unload the machine and/or components from/onto the means of transport, use a lift truck or fork lift equipped with forks that are at least half the length of the machine housing; use a crane if the machine is fitted with eye bolts. Select the lifting equipment suited to the weight and overall dimensions of the packaged machine/components.
- When handling the machine/ components, apply all precautions to prevent damage, in compliance with the information given on the packaging material (fig. 1).

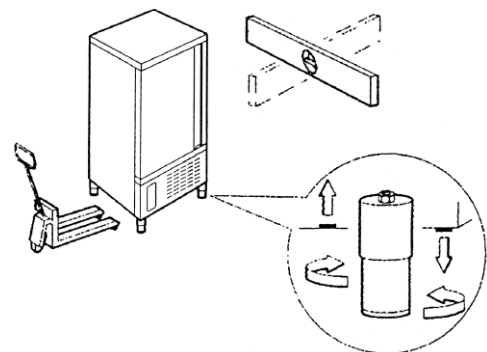

## 1.4 Unpacking

- Remove all cardboard, wood or other materials from the wood base on which the machine is set. Lift the machine/components with suitable means (e.g. lift truck), remove the wood base, then position the machine/components in the allocated

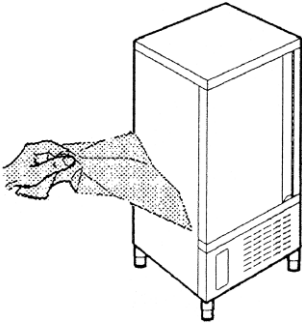

site.

- Once all packing material has been removed, check that the machine has not been damaged in any way.
- Remove the protective PVC film on the stainless steel

panels from all internal and external surfaces (fig. 2).

- **Always wear protective gloves when handling packing material and the wood base.**
- NB Dispose of packing materials in compliance with disposal regulations applied in the country where the machine is to be installed. Never dispose of materials in the environment.

## 1.5 General safety regulations

Failure to observe the recommendations made by the present manual will be at the entire responsibility of the machine user. The main safety regulations are as follows:

- **do not touch the machine with moist or wet hands or feet;**
- **never operate the machine while bare-foot;**
- **do not insert screwdrivers, cooking utensils or any other object between the guards and moving parts;**
- **before performing cleaning or routine maintenance operations, disconnect the machine from the power supply at the master switch and the main knife switch (if present);**
- **never pull on the power cable to disconnect the machine from the power supply.**



**WARNING !!!**  
**THESE OPERATIONS MUST BE**  
**PERFORMED BY A CERTIFIED INSTALLATION**  
**TECHNICIAN ONLY.**

## 2. INSTALLATION

### 2.1 Data plate information

- Check that the data specified on the plate correspond to the characteristics of the power supply (V, kW, Hz, no. phases and power available).
- The dataplate with appliance specifications is located at the rear exterior of the machine and/or on the electrical boards (fig. 3).

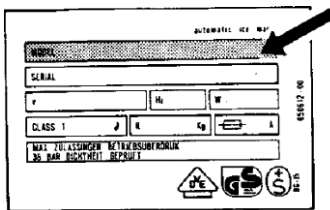

The set-up of individual units and the

installation of condensers are subject to the fire-safety regulations of the country in which the machine is installed; seek all necessary advice from the local fire-fighting authorities.

Bear in mind that the intervention of safety valves or plug fuses in the refrigerat-

ing circuit will lead to the immediate discharge of refrigerant into the environment.

### 2.2 Positioning

- The machine must be installed and commissioned in complete compliance with safety regulations, procedures and standing laws.
- The installation technician bears the responsibility of ensuring compliance with fire safety requirements; seek all necessary advice from the local fire-fighting authorities.
- Position the machine in the allocated site.
- Adjust the machine feet until the appliance is perfectly level. In the case of particularly heavy equipment, use appropriate lifting means

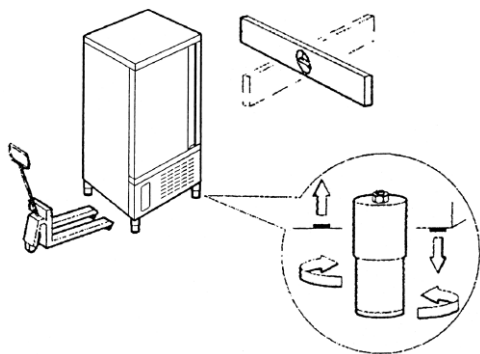

(fig. 1).

- If the appliance is not perfectly level, correct operation and condensate flow-off will not be assured.

#### AVOID

- direct exposure to sunlight;
- closed sites with high temperatures and poor air circulation;
- installing the machine near sources of heat (fig. 4).

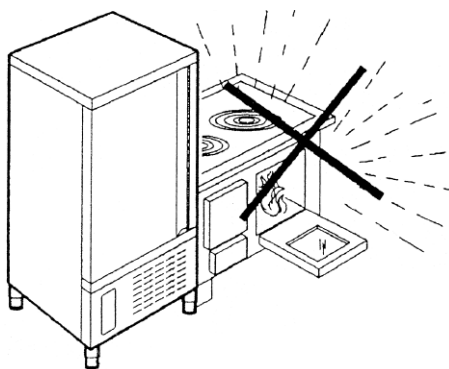

### 2.3 Ambient temperature and air circulation

For air-cooled appliances, the maximum ambient temperature for operation is 32°C. Correct operation cannot be guaranteed at higher temperatures.

The machine may operate safely to a maximum temperature of 38°C.

Remote condensing units must be installed in special rooms or outdoors, protected against direct sunlight by a shelter or roof structure (at the cost of the purchaser).

Sufficient air circulation must be guaranteed at all times.

### 2.4 Electrical connections

A dedicated thermal-magnetic circuit breaker compliant with established regulations must be installed on the appliance power line.

- Connected electrical cables must correspond to the technical data (as specified on electrical drawings provided by the installation technician).

Connect the earthing conductor to an efficient earthing system.

**THE MANUFACTURER DECLINES ALL LIABILITY AND GUARANTEE OBLIGATIONS IN THE EVENT OF INJURY TO PERSONS OR DAMAGE TO EQUIPMENT AND OBJECTS DUE TO INCORRECT INSTALLATION AND/OR FAILURE TO COMPLY WITH STANDING INSTALLATION REGULATIONS.**

#### CONNECTING THE APPLIANCE TO THE POWER SUPPLY.

In the event of damage to the power supply cable on the appliance, have the cable replaced only by a qualified electrician to avoid any risk of personal injury.

### 2.5 Refrigeration component connections - remote assemblies

Appliance power lines are sized for installation distances of up to 10 metres. For greater distances, seek advice from .

### 2.6 Condensate drainage connection

Fit a condensate/wash water drainage hose with a minimum diameter of 1" ("Geberit" or similar type).

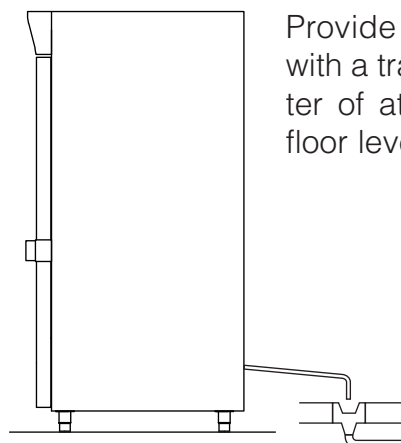

Provide a waste pipe with a trap with a diameter of at least 1 1/2" at floor level.

## 2.7 Information for the installation technician

Before starting up the machine, check that it has been correctly installed and commissioned (test report).

1. Check that there are no gas leaks from weldings or joints made during installation works.
2. Check that the pipes connecting the condenser to the remote condensing unit have been well insulated.
3. Check all wiring connections.
4. Check electrical input.
5. Check the standard pressure in the refrigerant system.
6. Check the water connections and efficiency of the pressure switch valve during operation, as well as the flow of condensing water (in water-cooled units).
7. Perform at least one blast freezing cycle (to the SET temperature) and one manual defrosting cycle.

In the event that the appliance or the remote condensing unit have not been transported in a vertical position (e.g. on the back) or have been overturned during installation works, allow at least 4 hours before starting up the equipment.

- Inform the customer of the exact purpose of the appliance, with specific reference to the use and requirements of the customer.

**The appliance must be installed and put into service by a technician authorised.**

## 2.8 Safety and control systems

- Door microswitch: shuts down fan operation in the cell when the door is opened.
- General fuses: protect the power circuit against short circuiting and overloads.
- Compressor heat relay: intervenes in the event of overloads or operating faults.
- Safety pressure switch: intervenes in the event of excessive pressure in the refrigerant circuit.

- Plug fuses: intervene in the event of over-pressure or operating fault in the safety pressure switch (see above).
- Chamber temperature control: operated by the electronic board by means of a probe inside the cell.
- Temperature control end defrost cycle: controlled by the electronic board by means of the probe in the evaporator.

## 2.9 Disposal of waste electronic and electrical equipment (WEEE) Fulfilling Directives 2002/95/CE, 2002/96/CE and 2003/108/CE on the disposal of waste electronic and electrical equipment.



The crossed out wheeled bin symbol indicates the product must be collected separately from other waste when it has become redundant. Differentiated collection of this equipment is arranged and handled by the manufacturer.

Consequently, the user who is wanting to dispose of this equipment must contact the manufacturer and follow the method the latter has adopted to allow separate collection of the redundant equipment.

Appropriate differentiated collection for the subsequent recycling, treatment and eco-friendly disposal of the dismantled equipment prevents possible negative effects on the environment and health and facilitates the recycling of materials used in manufacturing the equipment.

Administrative sanctions foreseen by the regulations in force shall be applied for any abusive disposal of the product by the holder.



## 3. ADVICE TO ENSURE EFFICIENT APPLIANCE OPERATION

### 3.1 Shut-down procedures

In the event of emergency, shut down the appliance by switching off power at the main panel, by means of the knife switch or by removing the plug from the power socket.

### 3.2 Operating tips

Before starting up the appliance, clean the inside of the cell thoroughly.

#### 3.2.1 Pre-cooling

Before using the appliance for the first time, or after a prolonged period of disuse, pre-cool the cell by running an empty cycle until the set operating temperature has been reached.

To ensure optimal performance without any alteration to food quality: arrange food products in such a way as to favour the circulation of cold air throughout the cell; open the door as little as possible.

#### 3.2.2 Loading the appliance

- a) Ensure that foods to be chilled and/or frozen are separate and do not have a thickness greater than 50-80 mm. Do not load the appliance beyond the quantity recommended by the manufacturer.

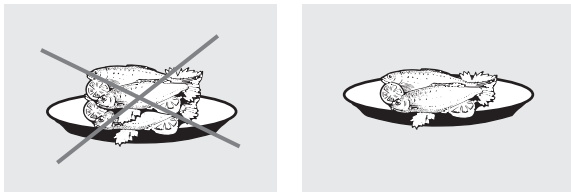

- b) Ensure that there is sufficient clearance between trays to enable free air circulation.

If the appliance is not completely full, distribute the trays and foods evenly throughout the available space.

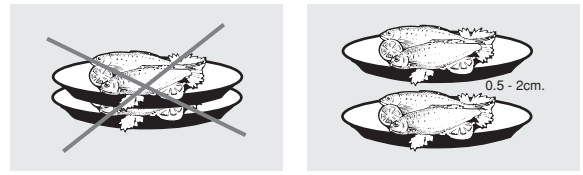

- c) Position trays inside the tray compartment as far as they will go, as close as possible to the evaporator.

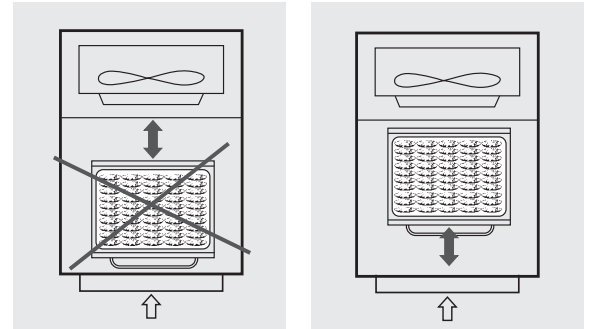

- d) Position the core probe at the centre of the largest product or food item; make sure that the tip of the probe does not protrude or touch the tray. The probe must be cleaned and sanitised before each new cycle (operation) to prevent inadvertent contamination.

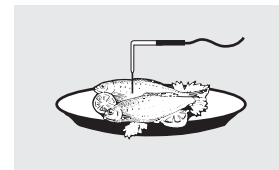



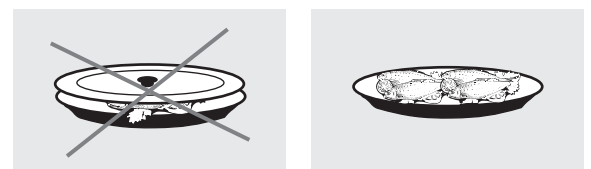



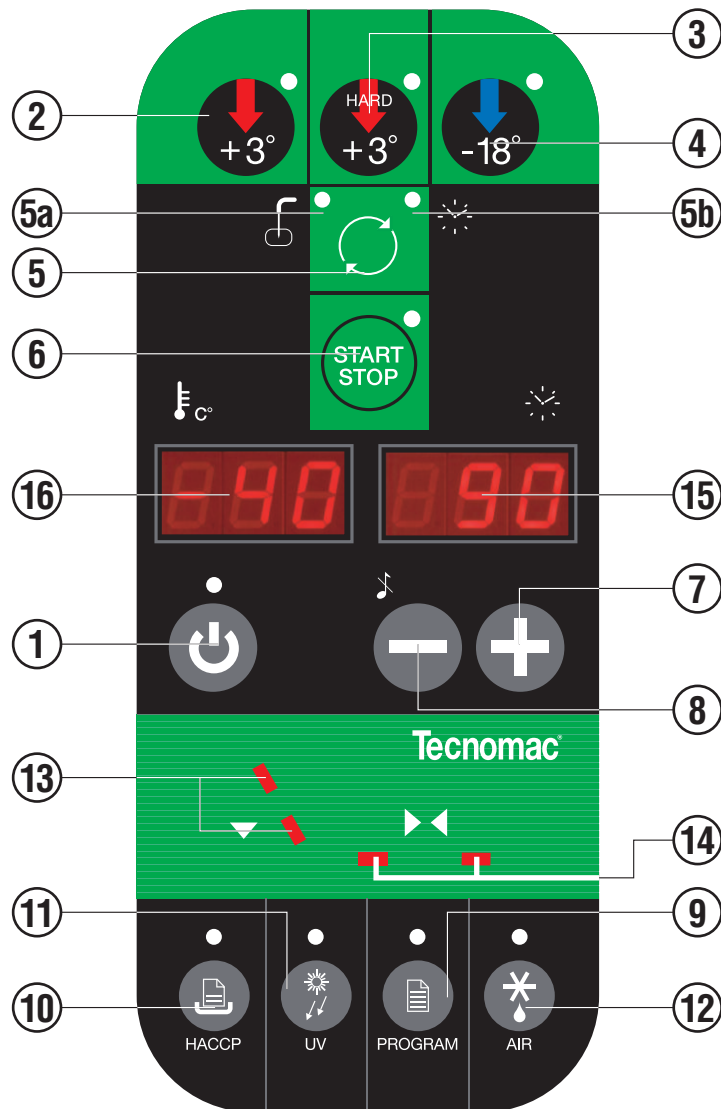









- e) Avoid covering the trays and/or containers with insulating covers or film. The more the product is insulated, the more time is required for chilling or freezing. Trays must be packaged when the product has been chilled, before being placed in storage.



## 4. DESCRIPTION OF THE VERTICAL CONTROL PANEL

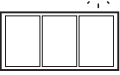
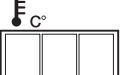

## 4.1 PUSH-BUTTONS :

1.  ON /OFF (STAND BY)
2.  SOFT BLAST CHILLING CYCLE (+3 °C)
3.  HARD BLAST CHILLING CYCLE (+3°C)
4.  BLAST FREEZING CYCLE (-18°C)
5.  END CYCLE BY TIME / PROBE (TEMPERATURE)
- 5A.  PROBE CHILLING INDICATOR LED
- 5B.  TIMED CHILLING INDICATOR LED
6.  CYCLE START / STOP
7.  INCREASE VALUE
8.  DECREASE VALUE
9.  RECIPE PROGRAMS (CHILLING CYCLES)
10.  HACCP AND PRINTER (OPTIONAL)
11.  STERILIZATION BY UV-C LAMP (OPTIONAL)
12.  DEFROSTING / FORCED VENTILATION
13.  CHILLING / FREEZING CYCLE INDICATOR LED
14.  STORAGE INDICATOR LED
15.  TIME DISPLAY
16.  TEMPERATURE DISPLAY

## 5. PROGRAMMING AND OPERATING INSTRUCTIONS



**IMPORTANT!!!**  
**IN THE EVENT OF MALFUNCTION, SEEK THE ASSISTANCE OF A CERTIFIED TECHNICIAN**

### Delayed start of compressor during first starting

(for models E15-40 / E15-65 / E15.2-70)

#### Pre-heating function of compressor sump

When the board is reached by mins tension, a 2-hour pre-heating phase starts and the display shows some blinking dashes “---”. During this phase the machine cannot be started.

#### NOTE

The delayed start takes place only if the machine is given power by its dedicated magneto-thermic switch.







It is therefore advisable that, after first starting, the machine is started or stopped by using the control panel pushbutton. This way, the compressor pre-heating function is guaranteed, and the machine starting takes place in a direct way.

Initial pre-heating is necessary in order to safeguard the compressor's life. Only if strictly necessary (and under the customer's responsibility) it is possible to by-pass countdown by pressing the pushbutton “printer/HACCP” for about 5 seconds

**This function is not activated if machine stops/starts operating due to lack of power during working cycle.**

### 5.1 STARTING UP THE APPLIANCE

When the appliance is powered up, it can be:

- **ON** displays 15  and 16  and left LED 5A  on push-button 5  on, LED 1  off
- **OFF-STAND-BY** LED on push-button 1  on

To switch from one status to another, press push-button 1 .

Whenever the appliance switches from STAND-BY status to ON, a self-test is carried out: all LEDs and displays are switched on, push-buttons are checked, then the installed software version is displayed.

### OPERATION

The main work cycles (chilling/freezing) performed by the appliance:

- **SOFT BLAST CHILLING (+3°C)**  
 Pre-cooked food is rapidly chilled (90') to a temperature of +3°C, thus preventing proliferation of bacteria and preventing dehydration of the cooked food due to evaporation. Food can thus be stored perfectly for 5 to 7 days without altering its original qualities.
- **HARD BLAST CHILLING (+3°C)**  
 This process is designed to cool food products with a thickness greater than 2-3 cm. Variable air temperatures are used to accelerate penetration of cold into the product.

- **BLAST FREEZING (-18°C)**

This function freezes the product completely to a temperature of -18°C in less than 4 hours. The rapidity of the process prevents formation of macrocrystals essential to ensure that the product retains its original consistency and quality when thawed for consumption.

- **AUTOMATIC CONSERVATION**













At the end of each cycle (chilling or freezing), the appliance will automatically switch to the required storage temperature.



Two different end-cycle modes are available for each cycle:

- **BY TEMPERATURE** - the cycle ends when the probe reaches the required temperature.
- **TIMED** - cycle length is pre-set

**IMPORTANT: work cycles and modes can only be selected** when the appliance is **ON** (LED on push -button 6  off)

## 5.2 SOFT BLAST CHILLING BY TEMPERATURE (pre-cooked, hot foods)



- To select this cycle, press push-button 2  (relative LED lights up), then press push-button 5   to select the temperature mode (LED 5A  on)
- Insert the core probe into the core of the product to be chilled.
- Start up the cycle by pressing push-button 6 . LED 5A  and those relative to the push-buttons pressed illuminate throughout the cycle, while LEDs 13  flash.
- Display 15  indicates the maximum blast chilling time (starting temperature to end of the blast chilling temperature - factory setting - 90 minutes).
- The temperature measured by the core probe is shown by display 16 .
- The instrument timer starts the countdown of the maximum blast chilling time as soon as the temperature measured by the core probe falls below the temperature of +65°C (the dot at the bottom right of display 15  flashes).
- During the blast chilling cycle, the air temperature is around 0°C. This function is designed to guarantee uniform cooling of the product, preventing frost formation on the surfaces. During the blast chilling cycle, the compressor may therefore stop and restart, depending on the reading of the cell temperature probe.
- The blast chilling phase ends only when the core probe (inserted in the product core) indicates that the set blast chilling temperature (+3°C) has been reached as signalled by an intermittent beep for a minute. During the beep, LEDs 13  and 14  flash.



Display 16  indicates the temperature inside the cell, while display 15  shows blast chilling time reset to zero.

- If at the end of the maximum blast chilling interval the core probe continues to display a temperature higher than the value for the end of blast chilling, the displays will indicate an alarm for excessively long chilling (ALL 14) alternating with the temperature and time; at the same time, the alarm beep will be activated.  
The blast chilling cycle continues until the end chilling temperature has been reached; display 15  counts back the minutes remaining until the end of the cycle.

**NB: Press push-button 8  to mute the alarm; press push-button again to clear the alarm display**





- At the end of the chilling cycle, the appliance automatically switches to the set storage temperature for an indefinite interval (like a standard storage appliance).

**NB:** LEDs 13  switch off while LEDs 14  light up.





- The cell temperature is constantly shown on display 16 ; during this cycle, defrost cycles are performed at regular intervals with duration set as required (parameter programming reserved for installation technician). The factory setting for positive storage temperature is +2°C.
- Press push-button 6  to set the appliance to STOP status (relative LED switches off), ready for a new cycle.

To modify the final blast chilling temperature, consult the user programming instructions.

### 5.3 SOFT TIMED BLAST CHILLING

- Press push-button 2  (relative LED lights up), then press push-button 5  to select the timer mode (LED 5B  on). Display 15  shows the maximum chilling time (set by default to 90 minutes).

To modify this time, press push-buttons 7  and 8  (time in minutes).

- Press push-button 6  to start the appliance. LED 5B  and push-button LEDs remain on and LEDs 13  flash throughout the cycle.
- Internal cell temperature is shown on display 16 .
- When the maximum chilling time has counted back to 0, the chilling cycle is completed and the appliance automatically switches to the set positive storage temperature for an indefinite interval.
- LEDs illuminate and the beep is activated when the cycle is finished (as in the chilling cycle by temperature). The same applies for the positive storage function.

Press push-button 6  to set the appliance to STOP status (relative LED switches off), ready for a new cycle.











**IMPORTANT: Use the storage function sparingly. After chilling, food products should be placed in storage cabinets.**

## HARD BLAST CHILLING



When the HARD function is used, chilling takes place in two stages:



- an initial “Hard” stage when the air temperature is brought down to below 0°C in order to accelerate chilling;
- a second “Soft” stage, involving air temperatures around 0°C.

### 5.4 HARD BLAST CHILLING BY TEMPERATURE

- Press push-button 3  (relative LED lights up), then press push-button 5  to select the temperature mode (LED 5A  on). Insert the core probe into the core of the product to be chilled.
- Start up the cycle by pressing push-button 6 . LED 5A  and those relative to the push-buttons pressed illuminate throughout the cycle, while LEDs 13  flash.
- Display 15  indicates the maximum blast chilling time (starting temperature to end of the blast chilling temperature - factory setting - 90 minutes).
- The temperature measured by the core probe is shown by display 16 .
- The instrument timer starts the countdown of the maximum blast chilling time as soon as the temperature measured by the core probe falls below the temperature of +65°C (the dot at the bottom right of display 15  flashes).
- Once the cycle has been started, the appliance operates initially with an air temperature below 0°C (LED on push-button 3  flashes), then with temperatures around 0°C (LED on push-button 3  on).

**NB:** The first stage of the cycle is completed when the core probe detects a temperature of +20°C in the product core.

- The blast chilling phase ends only when the core probe (inserted in the product core) indicates that the set blast chilling temperature (+3°C) has been reached as signalled by an intermittent beep for a minute. During the beep, LEDs 13  and 14  flash.

Display 16  indicates the temperature inside the cell, while display 15  shows blast chilling time reset to zero.





- The alarm (ALL 14) and conservation functions cut in with relative indicators in the same way as for timed Soft blast chilling.
- Press push-button 6  to set the appliance to STOP status (relative LED switches off), ready for a new cycle.

## IMPORTANT



HARD blast chilling affords a considerable reduction in working time, and is particularly suited to foodstuffs with a high fat content, for large pieces or for packaged products.



SOFT chilling is recommended for delicate and finely chopped products, such as vegetables, mousses, etc..

### 5.5 HARD TIMED BLAST CHILLING







- To select this cycle, press push-button 3  (relative LED lights up), then press push-button 5  to select the "timed" mode (LED 5B  on). Display 15  shows the maximum chilling time (set by default to 90 minutes).

To modify this time, press push-buttons 7  and 8  (time in minutes).

- To set the time of the first negative temperature stage, press push-button 3  for five seconds, then wait for display 15  to show the flashing value.







The time setting (in minutes) can be modified by means of push-buttons 7  and 8 .

Press push-button 3  again to return to standard display.

- Start up the cycle by pressing push-button 6 . LED 5B  and push-button LEDs remain on and LEDs 13  flash throughout the cycle.
- Internal cell temperature is shown on display 16 .
- Once the cycle has been started, the appliance operates initially with an air temperature below 0°C (LED on push-button 3  flashes), then with temperatures around 0°C (LED on push-button 3  on). For example: HARD timed chilling cycle 90 minutes. First stage of 40 minutes with negative air temperature. Second cycle stage of 50 minutes with air temperature around 0°C.
- When the maximum chilling time has counted back to 0, the chilling cycle is completed and the appliance automatically switches to the set positive storage temperature for an indefinite interval.
- LEDs illuminate and the beep is activated when the cycle is finished (as in the temperature chilling cycle). The same applies for the storage function.
- Press push-button 6  to set the appliance to STOP status (relative LED switches off), ready for a new cycle.







## 5.6 BLAST FREEZING BY TEMPERATURE

- To select this cycle, press push-button 4  (relative LED lights up), then press push-button 5  to select the temperature mode (LED 5A  on). Insert the core probe into the core of the product to be chilled.
- Start up the cycle by pressing push-button 6 . LED 5A  and those relative to the push-buttons pressed illuminate throughout the cycle, while LEDs 13  flash.
- The appliance proceeds to operate in the same way as that described for the positive chilling cycle. During this cycle the compressor operates in continuous mode to enable the appliance to reach the cycle end temperature in the shortest time possible (default temperature at product core is set at -18°C). Maximum freezing time is 240 minutes.
- The alarm (ALL 14) for excessively-long freezing and conservation functions cut in with relative indicators in the same way as for timed Soft blast chilling. The factory setting for negative storage temperature is -25°C.
- LEDs illuminate and the beep is activated when the cycle is finished (as in the soft chilling cycle by temperature). The same applies for the storage function.

Press push-button 6  to set the appliance to STOP status (relative LED switches off), ready for a new cycle.

## 5.7 TIMED BLAST FREEZING

- Press push-button 4  (relative LED lights up), then press push-button 5  to select the timer mode (LED 5B  on). Display 15  shows the maximum chilling time (set by default to 240 minutes).

To modify this time, press push-buttons 7  and 8  (time in minutes).

- Start up the cycle by pressing push-button 6 . LED 5B  and push-button LEDs remain on and LEDs 13  flash throughout the cycle.

Internal cell temperature is shown on display 16 .

- When the maximum chilling time has counted back to 0, the cycle is completed and the appliance automatically switches to the set negative storage temperature for an indefinite interval.  
LEDs illuminate and the beep is activated when the cycle is finished (as in the freezing cycle by temperature). The same applies for the storage function. The factory setting for negative storage temperature is -25°C.
- Press push-button 6  to set the appliance to STOP status (relative LED switches off), ready for a new cycle.



## 6. APPLIANCE FUNCTIONS



### 6.1 DATE AND TIME SETTINGS : PUSH-BUTTON (5)

Set the machine to **ON** .

Press and hold down push-button 5  for more than five seconds to access the date and time setting function. Display 16



 indicates in sequence the abbreviations Hr (hours), Mn (minutes), dA (day), Mo

(month) and Yr (year), while display 15  shows their respective settings. To scroll the abbreviations, press push-button 5 .



To modify the settings, use push-buttons 7  and 8 .

### 6.2 ICE CREAM SURFACE HARDENING PUSH-BUTTON (6)

Set the machine to **ON** .

Press and hold down push-button 6  for more than five seconds to access the surface hardening function (push-button LED flashes). The compressor is switched on; display 15  shows the default cycle time.

Set the cycle time (in minutes) by means of

push-buttons 7  and 8 . Open the cell door, place the product inside, then shut the door to start the cycle. All LEDs remain off, with the exception of the Start LED. When the cycle time has elapsed, an acoustic signal is given. The appliance remains on, ready for another ice cream hardening cycle. Open the cell door, remove the hardened product, replace it, then shut the door. The machine will perform another hardening cycle for the time set for the previous one. Every time the door is opened and closed after a cycle, the time is reset.

To exit the function, press push-button 6 .

### ADDITIONAL FUNCTIONS

#### 6.3 MUTING THE BEEPER AND ALARM RESET : PUSH-BUTTON (8)

Press push-button 8  to mute the alarm beeper.

Alarms are reset :

- by pressing push-button 8  when the beeper is off;
  - automatically if alarm conditions are removed;
- see also section 7 (Alarm Management).

#### 6.4 PROGRAM STORAGE: PUSH-BUTTON (9)

The programming function is used for cycles for processing products with the same characteristics. Up to 99 programs can be stored. Select the type of chilling process (Soft, Hard, Timed Freezing or by Temperature), then press and hold push-but-

ton 9  until display 16  shows the

abbreviation P1 (push-button 9  LED flashes).







Use push-buttons 7  and 8  to set the

number of the program on display 16 . Start up the cycle by pressing push-button 6

. When the cycle has been completed, the appliance automatically switches to the set storage temperature for an indefinite time.

Press push-button 6  to set the appliance to STOP status (relative LED switches off), ready for a new cycle.

## RECALLING A STORED PROGRAM

When the appliance is **ON** , press push-button 9  briefly; display 16  will show program P1. Use push-buttons 7  and 8  to select the required program. Start up the cycle by pressing push-button 6 .

## 6.5 DISPLAYING THE THREE LATEST HACCP ALARMS (PUSH-BUTTON 10)

Set the machine to **ON** .

Press and hold down push-button 10  for more than five seconds (relative LED illuminates) to enter the alarm display function (date, hour and minute, alarm type and maximum temperature detected).

Every time the HACCP push-button is pressed, the stored data are displayed.

### EXAMPLE:

ALL.11	Display 15	Display 16
	---	Str (start)
	12	hr hour
	29	min minutes
	6	day days
	8	mon month
	03	yr year
	End	end
	13	Hr
	21	min
	6	day
	8	mon
	03	yr
	24	maximum temperature detected inside the cell

## 6.6 PRINTING OUT STORED DATA PUSH-BUTTON (10)

With the appliance in **STAND-BY** status,



press and hold down push-button 10  for more than five seconds to print out the latest work cycle.

(With the appliance in STAND-BY status,

press push-button 10  once to print out HACCP data). When the appliance is operating and the printer is on, the current cycle will be printed out.

## 6.7 FORCED VENTILATION FUNCTION

To activate this function when the appliance

is **ON** , press push-button 12  for more than five seconds. The fan will continue to operate even when the cell door is open.

During forced ventilation, display 16  will show "AIR".

## 6.8 MANUAL DEFROSTING

To activate this function when the appliance

is **ON** press push-button 12  (relative LED illuminates).

If conditions allow it (the temperature detected by the evaporator probe must be lower than the set point in the program parameters), the appliance will perform a defrost

cycle. Display 16  will show "dEF".

To immediately stop a defrost cycle, press

push-button 12 .

## 6.9 AUTOMATIC DEFROST CYCLES (NOT AVAILABLE FOR E5-14)

The appliance automatically performs defrost cycles during storage. Three defrost cycles are performed during a 24-hour period (once every 8 hours).

The appliance automatically restarts once the defrost cycle has been completed.

## 6.10 UV-C LAMP FUNCTION

Use this function to sterilize the interior of the cell.





When the appliance is **ON** , press push-







button 11  (relative LED illuminates). The UV-C lamp switches on and sterilizes the interior for a default time of 30 minutes. To interrupt the sterilization cycle, press push-





button 11  or open the cell door. When the door is closed again, the lamp will remain off.

## 6.11 USER ENTRY TO PROGRAMMING DATA

Access for programming configuration parameters is only permitted when the appliance is **ON** and there is no data memory error **active**.

Press and hold down push-buttons 7  and 8  at the same time for more than five seconds; the computer will give access to the programming function. Display 16  displays PA, while display 15  will show the relative value.

Use push-button 5    to select parameter display (LED 5A  illuminated), or display 16  with settings (LED 5B  illuminated).

Use push-buttons 7  and 8  to scroll the list of parameters (if LED 5A  is illuminated) or to modify the settings (if LED 5B  is illuminated). The computer automatically exits the programming function after approximately 40'.

## 6.11 PRINTER (OPTIONAL)

- If you have to turn the instrument on/off press



- If you have to feed the paper by hand press



- If you have to change the roll of paper:  
Turn the instrument off

Press  for opening the panel at the front of the instrument

Slip the roll of paper into the lower side of the roller

Press  as long as the roller drags the roll of paper

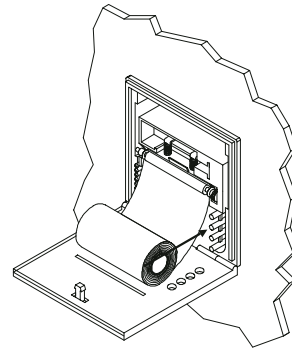

Put the roll of paper into its box

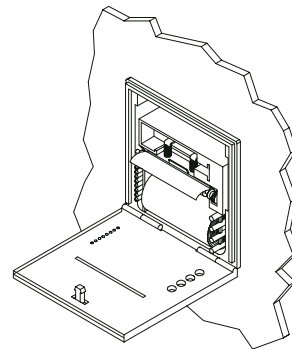

Close the panel at the front of the instrument

- If you have to execute the print test  
Switch off the power supply of the instrument

Press 

Switch on the power supply of the instrument

- Signals: on/off led - if it is lighted, the instrument will be in ON mode

## USER PARAMETER SETTINGS

	Parameter	Min.	Max.	Unit/meas.	DEF
PA	PASSWORD	-99	+99	Number	-19
	<b>/ = PROBE PARAMETERS</b>				
/1	Cell probe calibration	-10	+10	°C	0
/2	Evaporate probe calibration	-10	+10	°C	0
/3	Core probe calibration	-10	+10	°C	0
/8	Temperature scale (0=Fahrenheit 1=Celsius)	0	1	Flag	1
	<b>c = CHILLING / FREEZING</b>				
c0	Cell probe differential	1	15	°C	+3
c1	Duration of timed chilling and max. duration for chilling by temperature	0	400	min	90
c2	Chilling end set point (core probe)	-55	+99	°C	3
c3	Positive storage set point (cell probe)	-55	+99	°C	2
c4	Duration of timed freezing and max. duration of freezing by temperature (when c4=0, key and freezing function to -18°C are disabled. For chilling units only.)	0	400	min	240
c5	Freezing end set point (core probe)	-55	+99	°C	-18
c6	Negative storage set point (cell probe)	-55	+99	°C	-25
c8	Positive and negative chilling duration countdown start temperature	-55	+99	°C	+65
cA	Core probe readout (readout only)	---	---	°C	---
cb	Set point for SOFT blast chilling (cell probe) and during second stage of HARD blast chilling	-55	+99	°C	-5
cd	HARD chilling set point (temperature transition HARD ->SOFT of core probe)	-55	+99	°C 2	0
cF	Cell set point during first stage of HARD blast chilling (core probe)	-55	+99	°C	-20
	<b>d = DEFROST</b>				
d0	Defrosting interval (0 = no defrost)	0	99	hours	8 h
dA	Defrost probe readout (readout only)	---	---	°C	---
	<b>U = INPUTS + VARIOUS</b>				
u5	Duration of UV lamp activation (if u5=0, UV key is disabled)	0	99	min	0
uA	Print interval (when uA=0, HACCP key is disabled)	0	99	min	20

## 7. ALARM MANAGEMENT

### 7.1 Storage of data/errors

The appliance electronic controller is equipped with a system of acoustic and visual signals to indicate the intervention of safety devices. The table below gives a list of the alarms shown on the panel display

### 7.2 The software controls the following alarms:

<b>Evaporator probe alarm (ALL 01)</b>	
<b>Cause:</b>	Exit from operating range (-50°C / +100°C) for over 30 seconds. Probe is defective (REPLACE PROBE).
<b>Beeper:</b>	Activated (3 seconds, then a pause of 30 seconds) until the mute button is pressed.
<b>Display:</b>	Alternates message "ALL 01" with standard display
<b>Reset:</b>	Automatically resets only when probe reading has returned to normal.
<b>Core probe alarm (ALL 02)</b>	
<b>Cause:</b>	Exit from operating range (-50°C / +100°C) for more than 30 seconds during current chilling cycle by temperature.
<b>Effect:</b>	Interruption of current chilling cycle by temperature and automatic start-up of timed chilling cycle. Chilling by temperature push-button disabled. Probe is defective (REPLACE PROBE).
<b>Beeper:</b>	Activated (3 seconds, then a pause of 30 seconds) until the mute button is pressed.
<b>Display:</b>	Alternates message "ALL 02" with standard display
<b>Alarm relay:</b>	Not activated.
<b>Reset:</b>	Press the mute push-button (with beeper off). Resets automatically if probe value returns to normal, but cycle remains in timed mode. Alternatively, switch off the panel then turn it back on (stand-by).
<b>Cell probe alarm (ALL 03)</b>	
<b>Cause:</b>	Exit from operating range (-50°C / +100°C) for over 30 seconds. Probe is defective (REPLACE PROBE).

<b>Effect:</b>	Any current chilling cycle is interrupted. If a storage phase is in progress, the compressor and the fan set to stand-by status. When the appliance is in Stop status, press Start to set the compressor and fan to stand by.
<b>Beeper:</b>	Activated (3 seconds, then a pause of 30 seconds) until the mute button is pressed.
<b>Display:</b>	Alternates message "ALL 03" with standard display
<b>Reset:</b>	Automatically resets only when probe reading has returned to normal.

**Optional probe alarm (ALL 04)  
(disabled if no probe is connected)**

**Input SW2 (ALL 05) (door microswitch alarm)**

<b>Cause:</b>	Input active for more than 5 minutes with appliance in start status. Door open (close door) Microswitch fault (replace the microswitch)
<b>Beeper:</b>	Activated (3 seconds, then a pause of 30 seconds) until the mute button is pressed.
<b>Display:</b>	Alternates message "ALL 05" with standard display
<b>Reset:</b>	Press the mute push-button (with beeper off). Automatically resets if input value returns to normal Alternatively, switch off the panel then turn it back on (stand-by).

**Input SW1 alarm (ALL 06)  
(Press. max for all models)  
(Thermal-magnetic switch for E15-40 / E15-65 / E15.2/70 / T14/2 / E20 / T20 / T24 / T30 / T40 / T50 models)  
(Oil diff. pressure switch for E20 / T20 / T30 / T40 / T50 models)**

<b>Cause:</b>	Input active for more than 5 seconds
<b>Effect:</b>	Sets the appliance to STOP. Reset the max. pressure switch, thermal-magnetic switch or differential pressure switch.
<b>Beeper:</b>	Activated (3 seconds, then a pause of 30 seconds) until the mute button is pressed.
<b>Display:</b>	Alternates message "ALL 06" with standard display
<b>Reset:</b>	Press the mute push-button (with beeper off) with no alarm cause displayed

**Input SW4 alarm (ALL 07)**

**(Automatic reset min. idrostat pressure switch for all water cooled models)  
(Automatic reset min. pressure switch for E20 / T20 / T24 / T30 / T40 / T50)**

<b>Cause:</b>	Input active for more than five seconds when appliance in start mode The alarm is disabled for approx. two minutes at each compressor start-up. The alarm is disabled during "pump-down". If the alarm persists, contact SERVICE.
<b>Effect:</b>	Appliance sets to STOP. Start/Stop and Defrost push-buttons are disabled.
<b>Beeper:</b>	Activated (3 seconds, then a pause of 30 seconds) until the mute button is pressed.
<b>Display:</b>	Alternates message "ALL 07" with standard display
<b>Reset:</b>	Press the mute push-button (with beeper off). Alternatively, switch off the panel then turn it back on (stand-by).

**Input SW3 alarm (ALL 08)**

**(Kriwan compressor automatic reset only for E15-40 / E15-65 / E15.2/70 / T14/2 / E20 / T20 / T30 / T40 / T50 models)**

<b>Cause:</b>	Input active for more than five seconds at least three times when appliance is in start mode
<b>Effect:</b>	Compressor shuts down and resumes operation when input value returns to normal. The appliance sets to STOP at third alarm.
<b>Beeper:</b>	Activated (3 seconds, then a pause of 30 seconds) until the mute button is pressed.
<b>Display/Led:</b>	Alternates message "ALL 08" with standard display
<b>Reset:</b>	Press the mute push-button (with beeper off). Alternatively, switch off the panel then turn it back on (stand-by).

**Input Ht1 alarm (ALL 09)**

**(Input in voltage 1 ... fuses)**

**Input Ht2 alarm (ALL 10)**

**(Input in voltage 2 ... fuses)**

**Excessive temperature alarm (ALL 11)**

<b>Cause:</b>	(only during storage) cell probe constantly detects a temperature greater than the sum of positive or negative storage set points with relative alarm delta.
---------------	--



**Blackout alarm (ALL 12)**

**Cause:** (only during storage) after the return of power the cell probe detects a temperature greater than the sum of positive or negative storage set points with relative alarm delta.

This alarm is disregarded if the storage probe is already in alarm status.

**Compressor preventive maintenance alarm (ALL 13)**

**Cause:** Compressor operating time is a whole multiple of hours set under password.

**Temperature not reached in set time alarm (ALL 14)**

**Cause:** Blast chilling by temperature has lasted longer than the time set for Timeout

**Effect:** Store the alarm in HACCP memory  
Chilling cycle continues.

**Beeper:** Activated (3 seconds, then a pause of 30 seconds) until the mute button is pressed.

**Display:** Alternates message "ALL 14" with standard display

**Alarm relay:** Not activated.

**Reset:** Press the mute push-button (with beeper off).  
Alternatively, switch off the panel then turn it back on (stand-by).

**Keyboard/membrane alarm (ALL 15)**

**Cause:** A pressed push-button has been detected when panel is switched on.

**Effect:** All keys are disabled.  
All relays are disabled. All inputs are disregarded. The LED indicator of the pressed button flashes.

**Beeper:** Activated (3 seconds, then a pause of 30 seconds) until the mute button is pressed.

**Display:** Alternates message "ALL 15" with standard display

**Reset:** Switch off the panel then turn it back on (stand-by).

**NB:** The appliance cannot be used until this alarm has been removed.

## INFORMATION ON ALARMS:

During alarms, the beeper is activated and the display shows the message "ALL xx".

The alarm message is alternated on the display even when the beeper has been silenced, until the alarm has been cleared.

Alarm relays remain activated as long as the alarm is displayed.

In the case that more than one alarm has been activated, each one is alternately displayed.

When the beeper is activated, the operator can silence it by pressing the relative push-button, after which the alarm can be cleared, by pressing the beeper reset button again.

Power failures will not erase current alarms.

## List of other operating faults not indicated:

FAULT	CAUSE	SOLUTION
Compressor does not operate	1 - Overload switch has cut in 2 - Power failure	1 - Seek assistance from a service technician 2 - Check connection to power lines
Fans do not rotate	1 - Power failure 2 - Fan fault 3 - Condenser fault 4 - Protective fuse faulty	1 - Check connection to power lines 2 - Seek assistance from a service technician to replace fan 3 - Seek assistance from a service technician to replace condenser 4 - Seek assistance from a service technician to replace fuse
Electronic panel does not switch on	1 - Power failure 2 - Protective fuses broken	1 - Check connection to power lines 2 - Seek assistance from a service technician to replace fuses
Compressor operates but does not cool cell	1 - Shortage of refrigerant gas 2 - Solenoid valve fault 3 - Condenser is soiled	1 - Seek assistance from a service technician 2 - Seek assistance from a service technician 3 - Clean the condenser (see par. 4.2)

## 8. MAINTENANCE AND CLEANING



**WARNING !!!**  
**THESE OPERATIONS MUST BE PERFORMED**  
**BY A CERTIFIED INSTALLATION**  
**TECHNICIAN ONLY.**

The information and instructions given in this section address all persons operating the appliance: the user, the maintenance technician and non-specialised personnel.

**Ensure that the electrical power to the system has been disconnected before carrying out any cleaning or maintenance work on the appliance.**

### 8.1 GENERAL SAFETY REGULATIONS

Recall the following regulations to ensure that all cleaning and routine maintenance operations are conducted safely.

- do not touch the machine with moist or wet hands or feet;
- never operate the machine while bare-foot; - do not insert screwdrivers, cooking utensils or any other object between the guards and moving parts.
- before performing cleaning or routine maintenance operations, disconnect the machine from the power supply at the master switch and by pulling out the plug;
- never pull on the power cable to disconnect the machine from the power supply.

Removal of guards and safety devices for the purposes of routine maintenance is strictly prohibited. The manufacturer declines all responsibility for accidents caused by failure to observe the above regulation.

Before starting up the appliance, clean the inside of the cell thoroughly, as described in par. 8.3.

### 8.2 CLEANING THE CONDENSER

To ensure correct and efficient air condenser operation, it must be kept clean to allow free circulation of air. This operation should be performed at least once a month. Use a non-metal brush to remove all dust and debris from the condenser blades.

Use a vacuum cleaner to prevent the dust removed from being dispersed in the surrounding area. To remove greasy deposits, use a brush dipped in alcohol.

**NEVER USE POINTED OR ABRASIVE INSTRUMENTS TO SCRAPE APPLIANCE SURFACES.**

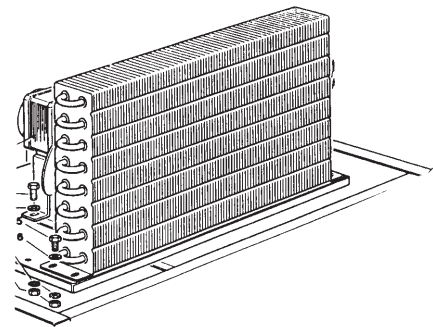

**PERFORM THIS OPERATION ONLY AFTER THE APPLIANCE HAS BEEN SHUT DOWN**

### IMPORTANT

The condenser has sharp edges. Always wear protective gloves, goggles and masks when carrying out the above operations.

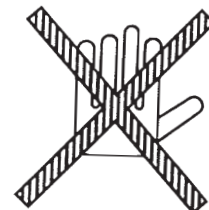

### 8.3 CLEANING THE CELL

To guarantee hygiene and ensure the quality of processed foods, clean the interior of the cell frequently, according to the type of food stored.

Weekly cleaning is recommended.

The cell interior and components can be cleaned with a soft cloth or sponge.



Clean with water and non-abrasive neutral detergents. Rinse with a damp cloth or sponge, or with a gentle jet of water (no stronger than mains pressure). Do not use pointed or abrasive instruments to scrape appliance surfaces. **NEVER USE ABRASIVE FLUIDS, SOLVENTS OR THINNERS.**

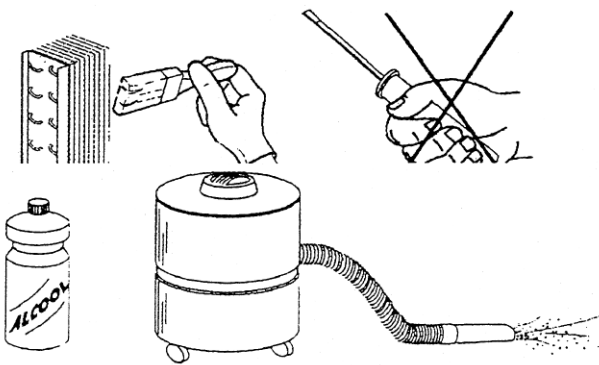

NB Always wear protective gloves while cleaning.

#### CLEANING AND MAINTENANCE

For the cleaning of the unit cabinet use a soft cloth with a mild detergent solution specific for Stainless Steel.



#### How to access the evaporator for cleaning.

It is possible to gain access to the inside part of the evaporator, to perform the cleaning of the same, by removing the screws located on the front fan panel (E15-Pict.1, E5-Pict.3) and opening it to the right side for E15 (Pict.2), or removing the panel on model E5. (Pict.4)

Pict. 1

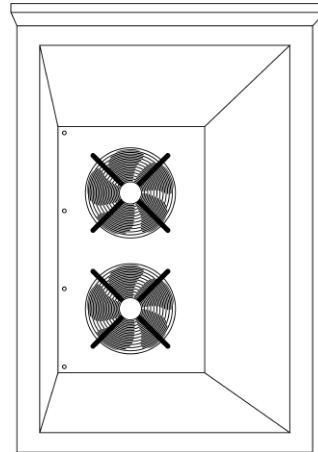

Pict. 2

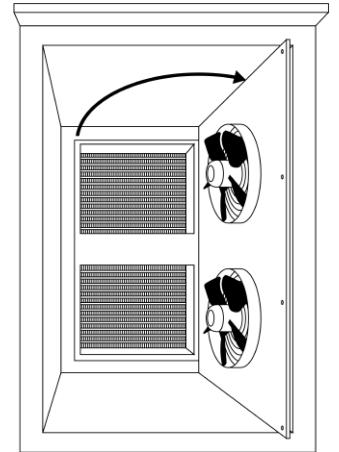

Pict. 3

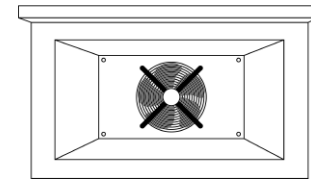

Pict. 4

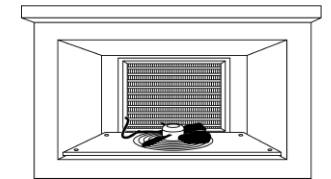

Periodically, provide to clean the evaporator, using nebulized hot water at low pressure, and addressing the water throw on the evaporator battery

Finished the cleaning, provide to dry the evaporator using air pressure in order to desiccate and remove the residues of presence of water . After that refit the fan panel in proper position.

To carefully clean with a cloth the surfaces adjacent to the evaporator and provide to reassemble the frontal fans panel.

**Important: Before starting the machine pls verify to have removed the equipments used in precedence for the cleaning.**

## 8.4 DEFROST WATER DRAINAGE

The system is prearranged for automatic and manual defrosting, as necessary.

Make sure that the water from the evaporator drains out into the collecting tray, and that the drain tube is not clogged.

## 8.5 PERIODIC CLEANING OF THE AIR CONDENSER FILTER (Only for E5-20 / E15-40 / E15-65)

Press with a screwdriver on both sides of front panel (see drawing). Take and clean the filter.

Put the filter in the original position. Push with the hands and close the panel.

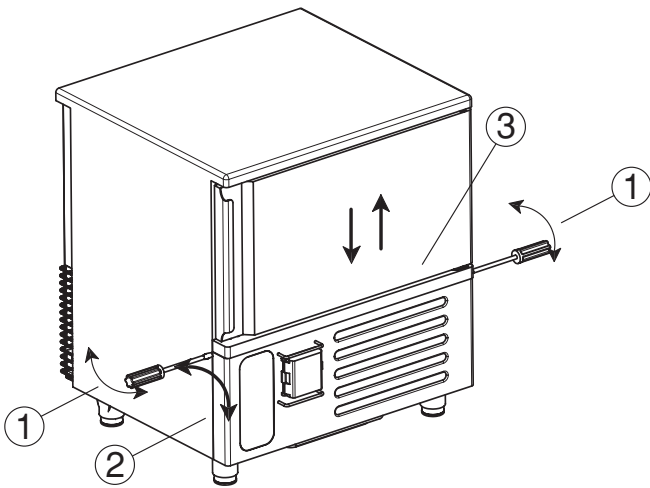





# Castel MAC SpA

Via del Lavoro, 9 C.P. 172  
I - 31033 Castelfranco Veneto (TV) Italy  
Tel. +39 0423 738455 - Fax +39 0423 722811  
E-mail: [service@castelmac.it](mailto:service@castelmac.it)  
Web-site: [www.castelmac.it](http://www.castelmac.it)

Cod. 71503788/0 - 10/2010 - Rev. 02

